



PRELIMINARY ENGLISH TEST
for Schools

Listening

CEP/SSU

SAMPLE TEST 2

Time Approximately 35 minutes (including 6 minutes' transfer time)

INSTRUCTIONS TO CANDIDATES

Do not open this question paper until you are told to do so.

Write your name, centre number and candidate number on your answer sheet if they are not already there.

Listen to the instructions for each part of the paper carefully.

Answer all the questions.

While you are listening, write your answers on the question paper.

You will have 6 minutes at the end of the test to copy your answers onto the separate answer sheet. Use a pencil.

At the end of the test, hand in both this question paper and your answer sheet.

INFORMATION FOR CANDIDATES

There are four parts to the test.

Each question carries one mark.

You will hear each piece twice.

For each part of the test there will be time for you to look through the questions and time for you to check your answers.

Listening • Part 1

Questions 1 – 7

There are seven questions in this part.
For each question there are three pictures and a short recording.
For each question, choose the correct answer **A**, **B** or **C**.

Example: Where is the girl's hat?

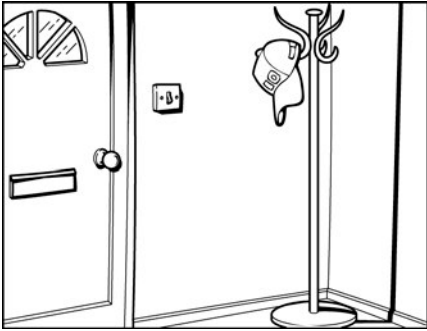

A

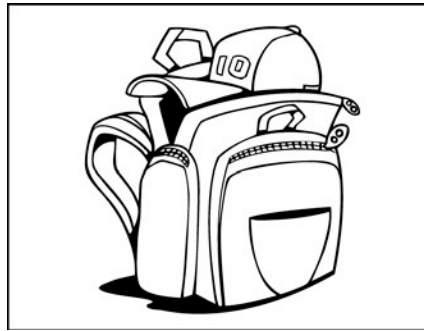

B

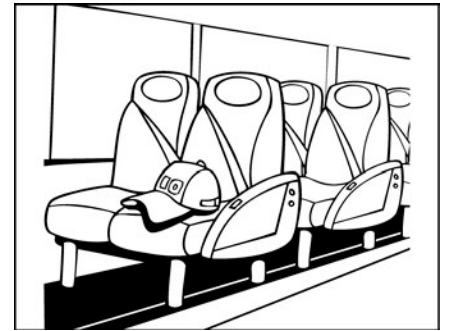

C

1 What did the girl enjoy most about her school project?



A



B



C

2 What does the boy want to do on Saturday?

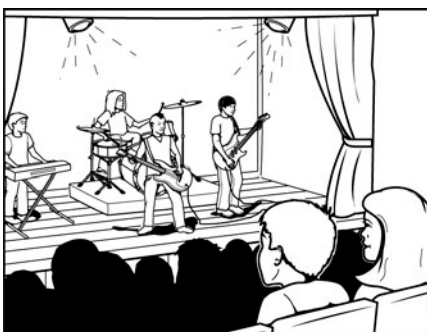

A

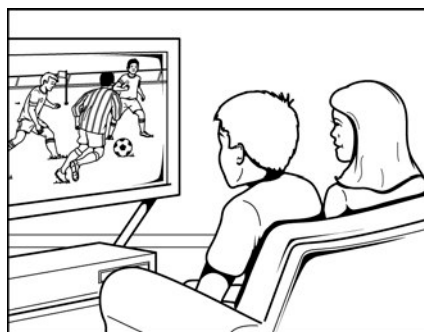

B

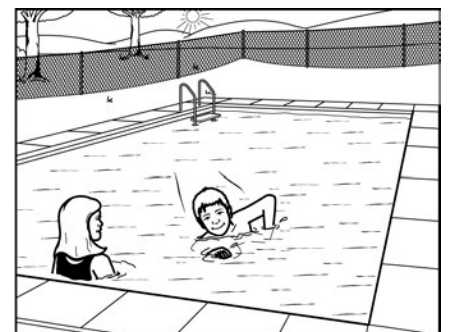

C

3 Which dress will the girl buy?



A

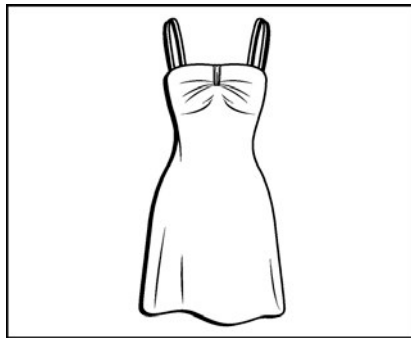

B



C

4 Which picture is the boy talking about?



A



B



C

5 What is the girl telling her classmates about?

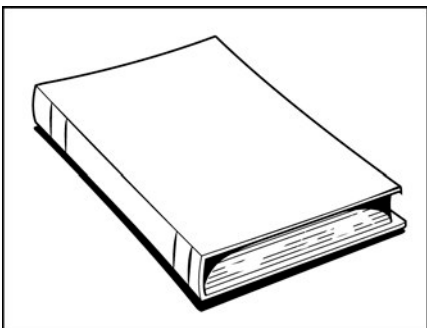

A

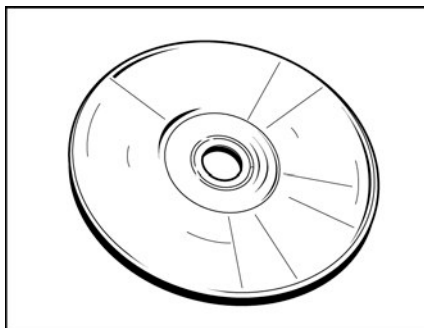

B

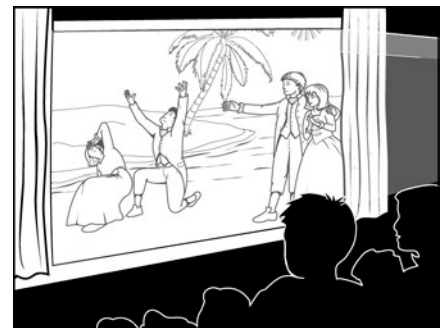

C

6 Where did the boy and his friends eat their lunch?



A



B



C

7 What isn't working properly in the boy's home?

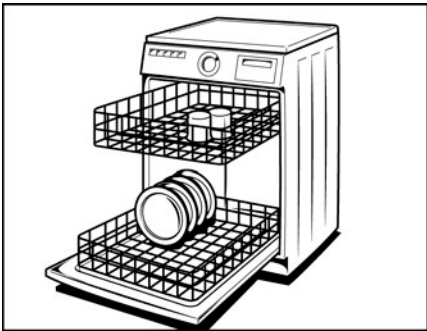

A



B

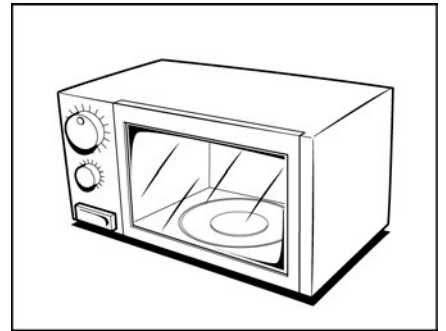

C

Listening • Part 2

Questions 8 – 13

You will hear a photographer called Joe Barnfield giving a talk to students at a school. For each question, choose the correct answer **A**, **B** or **C**.

- 8** What is Joe aiming to do in his talk?
- A** to teach the students some ways of taking better photos
 - B** to tell the students about the history of photography
 - C** to show the students some of his favourite photos
- 9** Joe became interested in photography when he was
- A** at school.
 - B** a university student.
 - C** doing his first job.
- 10** Joe believes that mobile phone cameras
- A** are convenient for some of his work.
 - B** take excellent quality pictures.
 - C** have made photography very popular.
- 11** Joe thinks it's a good idea to take photos of
- A** landscapes.
 - B** friends.
 - C** buildings.
- 12** What is Joe's advice to young photographers?
- A** delete photos that you're not pleased with
 - B** do a photography course
 - C** take pictures as often as you can
- 13** What does Joe like best about being a photographer?
- A** He always enjoys his work.
 - B** It lets him meet people.
 - C** He earns enough money from it.

Listening • Part 3

Questions 14 – 19

You will hear some information on the radio about a wildlife park. For each question, fill in the missing information in the numbered space.

Beechen Wildlife Park

The park is closed on **(14)**

The park has more **(15)** in its animal collection than other parks in the country.

This season the park has a new baby **(16)**

The park has its own **(17)** for visitors to travel round in.

Each animal has more **(18)** in their area than in many wildlife parks.

The park is offering free **(19)** for school groups.

Listening • Part 4

Questions 20 – 25

Look at the six sentences for this part.

You will hear a conversation between a girl called Rachel, and a boy called Andrew, about a rock group called The Rock Boys.

Decide if each sentence is correct or incorrect.

If it is correct, choose the letter **A** for **YES**. If it is not correct, choose the letter **B** for **NO**.

	YES	NO
20 Andrew thinks that the song 'Don't shout' deserved to win a prize.	A	B
21 Rachel thinks that the musicians in the group are nice people.	A	B
22 Rachel believes the majority of musicians can only dance or sing on stage.	A	B
23 Andrew admires the way the singer dresses.	A	B
24 Andrew finds that some of The Rock Boys' songs are amusing.	A	B
25 Rachel would rather see The Rock Boys in concert than get their CD.	A	B

PRELIMINARY for Schools SAMPLE TEST

LISTENING

PART 1

1	C
2	A
3	C
4	A
5	A
6	B
7	A

PART 2

8	C
9	A
10	C
11	B
12	A
13	C

PART 3

14	TUESDAY(S)
15	ZEBRAS
16	LION
17	(SPECIAL) VAN(S)
18	SPACE
19	PHOTOS

PART 4

20	B
21	A
22	A
23	B
24	A
25	B